

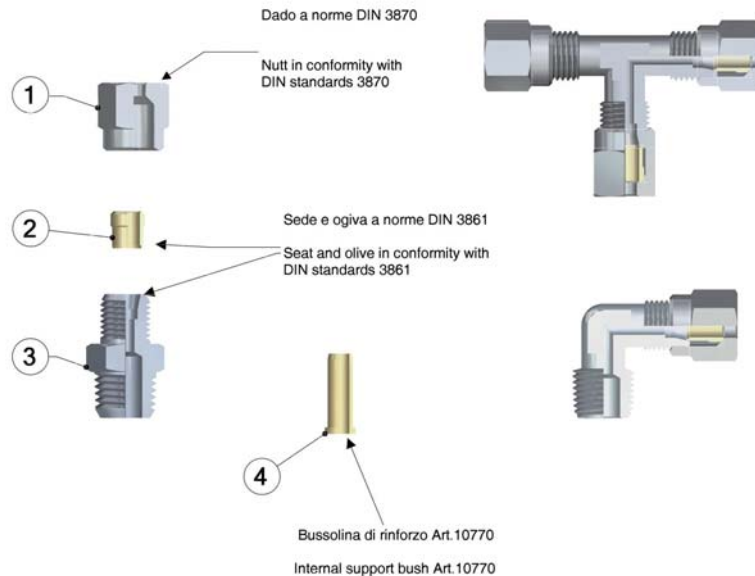

Serie / Series **9000**

RACCORDI A COMPRESSIONE
COMPRESSION FITTINGS

Caratteristiche Tecniche | Technical Characteristics



Scheda Materiali | Specifications

- | | |
|-----------------------------|----------------------------|
| 1 Corpo in Ottone nichelato | 1 Nickel-plated Brass Body |
| 2 Ogiva in Ottone Ricotto | 2 Annealed Brass Olive |
| 3 Dado in Ottone nichelato | 3 Nickel-plated Brass Nut |
| 4 Bussolina di rinforzo | 4 Internal support bush |

Pressioni e Temperature | Pressures and Temperatures

Pressioni e temperature vengono determinate dal tipo di tubo impiegato, pertanto tali valori sono da definirsi in base alle caratteristiche del tubo stesso. Riportiamo di seguito i valori delle pressioni massime consigliate per l'utilizzo dei raccordi con tubi di rame dallo spessore di 1 mm a 20° C.

The working pressures and working temperatures depend on which type of tube is used, for this reason, the values must be determined in accordance with the tube's features. Hereunder, we specify the values of the maximum pressure advised for the fittings at a temperature of 20° C connected with copper tube, which has a thickness of 1 mm.

I valori delle pressioni consigliate, riportate in tabella, sono stati ottenuti dai valori di prova adottando un Coefficiente di Sicurezza 4. Sono disponibili i certificati delle prove rilasciati dai vari laboratori che le hanno eseguite.

The values of working pressures advised, specified in table have been obtained from the test values using a Safety Factor 4. It is available the test report made by the external laboratory test.

Misura Size	Pressione Massima Consigliata Maximum Pressure Advised
ø 4LL	130 kg/cmq. - 128.6 Bar
ø 6LL	180 kg/cmq. - 178.1 Bar
ø 8LL	150 kg/cmq. - 148.4 Bar
ø 10L	115 kg/cmq. - 113.8 Bar
ø 12L	75 kg/cmq. - 74.2 Bar
ø 14S	70 kg/cmq. - 69.3 Bar
ø 16S	70 Kg/cmq. - 69.3 Bar
ø 18L	65 Kg/cmq. - 64.3 Bar

Filettature | Threads

Gas conica conforme ISO 7.1, BS 21, DIN 2999 / Tapered gas in conformity with ISO 7.1, BS 21, DIN 2999.
 Gas cilindrica conforme ISO 228 / Parallel gas in conformity with ISO 228.
 Metrica conforme ISO R/262 / Metric in conformity with ISO R/262.

Tubi di collegamento | Connection Tubes

Tubi in rame, ferro, acciaio, alluminio, ottone, ecc.
 Con apposito rinforzo interno (art. 10770), possono essere utilizzati anche tubi in PA11, PA6, ecc.

Tubes made in copper, steel, iron, aluminium, brass, etc. With an inside support bush (art. 10770), can be used also for plastic material such as PA11, PA6. etc.

Fluidi compatibili | Fluids

Acqua, olio, aria compressa, fluidi in genere per l'impiantistica idraulica, oleodinamica, idropneumatica, ecc.

Water, oils, compressed air, fluids in general for the hydraulic, pneumatic and oildynamic plants etc.

Istruzioni di Montaggio / Assembling Instruction

Serie / Series 9000 - 10000 - 13000

Per garantire le migliori prestazioni dei nostri raccordi, riportiamo una sequenza di operazioni da eseguire durante il montaggio, che contribuiranno ad eliminare sprechi di tempo e cattive applicazioni del prodotto.

To ensure the best function of our fittings, please follow the under mentioned instructions, in order to avoid waste of time and bad applications of the product.

1

Tagliare il tubo a 90° togliendo le bave interne ed esterne.

Cut the tube at 90° and remove internal and external burrs.

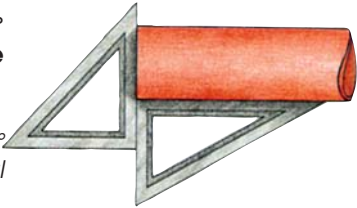
2

Oliare le filettature del dado e del corpo del raccordo, compresa l'ogiva.

Quindi infilare sul tubo dado e ogiva, facendo attenzione che quest'ultima abbia la parte tagliente verso il raccordo.

Lightly oil the tube nut, olive and fitting thread. Slide the nut and olive onto the tube ensuring that the sharp side of the olive is facing the fitting.

3

Avvitare manualmente il dado fino ad ottenere una certa resistenza dell'ogiva.

Screw the nut onto the fitting by hand until hand-tight.

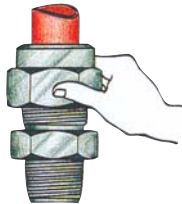
4

Verificare la completa adesione del tubo al corpo, forzando il medesimo verso l'interno del raccordo e quindi, con la chiave, bloccare il tubo.

Ensure the tube is pushed fully home into the fitting before tightening the nut with the correct spanner.

5

Stringere il dado (1 giro e 1/4 o 1/2) ponendo, se necessario, dei punti di riferimento.

Tighten the nut with the spanner one and a quarter turns, marking reference points, if necessary.

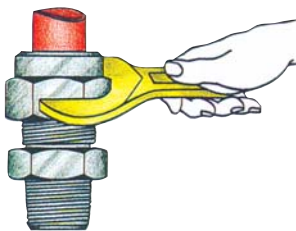
7

Riserrare il dado per circa 1/4 di giro.

Altra avvertenza per un buon montaggio: nel caso di tubi curvi, in prossimità del raccordo, il tubo stesso dovrà avere una distanza rettilinea almeno pari al doppio dell'altezza del dado.

Tighten the nut again with an extra quarter turn. Additional information to ensure correct assembly. Where fitting to curved tubes ensure that the section entering the fitting is straight for a minimum length of twice the nut height.

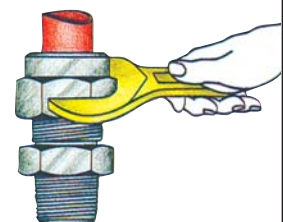
6

A garanzia che l'ogiva abbia inciso il tubo svitare il dado e controllare l'uniformità del solco.

To ensure that the olive has gripped the tube correctly. Unscrew the nut and make sure that the groove made by the olive is even.



COME ORDINARE

I raccordi standard della Serie 9000 prevedono:

- Trattamento superficiale di NICHELATURA
- Ogiva in ottone

Per formulare un ordine é sufficiente specificare **ARTICOLO, MISURA, QUANTITA'**.

HOW TO ORDER

The standard items of the 9000 series are supplied with:

- Surface treatment of NICKEL-PLATING
- Brass olive

To order simply specify the **ARTICLE CODE, SIZE and QUANTITY**.

9550

RACCORDO A L ORIENTABILE - SINGLE BANJO BODY

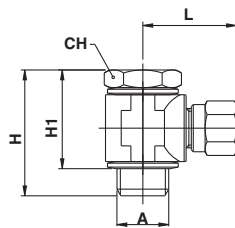

Tubo/Tube	A	L	H	H1	CH	Conf. Pack.
4	- 1/8	23.5	31	24	14	25
6	- 1/8	24	31	24	14	25
6	- 1/4	28	32	24.5	17	25
8	- 1/8	26.5	31	24	14	25
8	- 1/4	28.5	32	24.5	17	25
8	- 3/8	31	37.5	24.5	19	25
10	- 1/4	35	32	24.5	17	25
10	- 3/8	37.5	36	27.5	19	25
12	- 3/8	38	46	38	22	25



9 5 1 0

8 x 1/8

CODICE ARTICOLO
ARTICLE CODE

MISURA
SIZE

9200

RACCORDO A T INTERMEDIO - TEE CONNECTOR

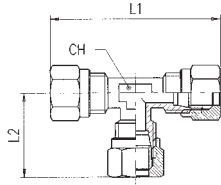

Tubo/Tube	L1	L2	CH	P	Conf. Pack.
4	46	21	8		25
6	48	22.5	9		25
8	53	25	12		25
10	65	31.5	13		25
12	68	33	14		25
14	76	42	17		10
15	78	38	17		10
16	86	42.5	20		10
18	90	44	22		10

9220

RACCORDO A T MASCHIO CENTRALE - TEE MALE ADAPTOR - CENTRE LEG

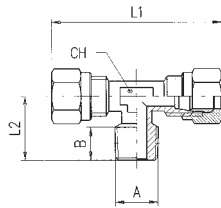

Tubo/Tube	A	B	L1	L2	CH	Conf. Pack.
4	- 1/8	7.5	45	15	8	50
6	- 1/8	7.5	45	16.5	9	25
6	- 1/4	11	45	20.5	9	25
8	- 1/8	7.5	52	17	12	25
8	- 1/4	11	52	20.5	12	25
8	- 3/8	11.5	50	24	13	25
10	- 1/4	11	64	23.5	13	25
10	- 3/8	11.5	64	24	13	25
12	- 3/8	11.5	68	25	14	25
12	- 1/2	14	68	26.5	14	25
14	- 1/2	14	84	30	17	25
15	- 1/2	14	76	28	17	25
16	- 1/2	14	85	31.5	20	10
18	- 1/2	14	88	34	22	10

9230

RACCORDO A T MASCHIO LATERALE - TEE MALE ADAPTOR OFF SET LEG

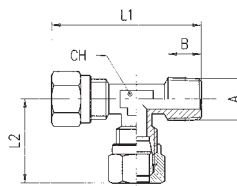

Tubo/Tube	A	B	L1	L2	CH	Conf. Pack.
4	- 1/8	7.5	37.5	21	8	50
6	- 1/8	7.5	39.5	22.5	9	25
6	- 1/4	11	43	23	9	25
8	- 1/8	7.5	43.5	25	12	25
8	- 1/4	11	47	25	12	25
8	- 3/8	11.5	50	25	13	25
10	- 1/4	11	55.5	31	13	25
10	- 3/8	11.5	56.5	31.5	13	25
12	- 3/8	11.5	59	33	14	25
12	- 1/2	11.5	59.5	25	15	25
14	- 1/2	14	68	42	17	25
15	- 1/2	14	68	38	17	25
16	- 1/2	14	74.5	42.5	20	10
18	- 1/2	14	79	44	22	10

9260

RACCORDO A L INTERMEDIO - ELBOW CONNECTOR

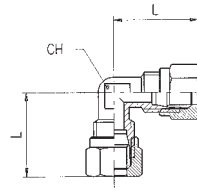

Tubo/Tube	L	CH	Conf. Pack.
4	21	8	50
6	22.5	9	50
8	26.5	12	25
10	31.5	13	25
12	34.5	14	25
14	38	17	25
15	37.5	17	25
16	44	19	10
18	44	22	10

9280

RACCORDO A L MASCHIO - ELBOW MALE ADAPTOR

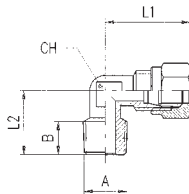

Tubo/Tube	A	B	L1	L2	CH	Conf. Pack.
4	- 1/8	7.5	22	15	8	50
6	- 1/8	7.5	23.5	17	9	50
6	- 1/4	11	24	19.5	9	50
8	- 1/8	7.5	26.5	18	12	50
8	- 1/4	11	26.5	21.5	11	25
8	- 3/8	11.5	29.5	24.5	13	25
10	- 1/4	11	33	23.5	13	25
10	- 3/8	11.5	33	24.5	13	25
12	- 3/8	11.5	34.5	25	14	25
12	- 1/2	14	34.5	28	15	25
14	- 1/2	14	38.5	30	17	25
15	- 1/2	14	37	29	17	25
16	- 1/2	14	43	31.5	19	10
18	- 1/2	14	44	33.5	22	10

9460

RACCORDO DIRITTO INTERMEDIO - STRAIGHT CONNECTOR

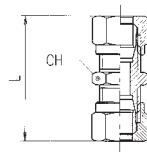

Tubo/Tube	L	CH	Conf. Pack.
4	36	9	50
6	39	12	50
8	39	12	50
10	48	17	25
12	49	19	25
14	53	24	25
15	50	24	25
16	53.5	27	10
18	53	27	10

9480

RACCORDO DIRITTO MASCHIO - STRAIGHT MALE ADAPTOR

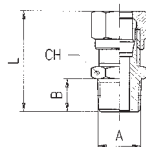

Tubo/Tube	A	B	L	CH	Conf. Pack.
4	- 1/8	7.5	27.5	11	50
6	- 1/8	7.5	28	11	50
6	- 1/4	11	31.5	14	50
8	- 1/8	7.5	30	12	50
8	- 1/4	11	33.5	14	25
8	- 3/8	11.5	35	17	25
10	- 1/4	11	38	16	25
10	- 3/8	11.5	38.5	17	25
12	- 3/8	11.5	38.5	18	25
12	- 1/2	14	41.5	21	25
14	- 1/2	14	44	22	25
15	- 1/2	14	43.5	22	25
16	- 1/2	14	45	24	10
18	- 1/2	14	45	26	10

9500

RACCORDO DIRITTO FEMMINA - STRAIGHT FEMALE ADAPTOR

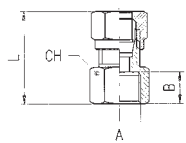

Tubo/Tube	A	B	L	CH	Conf. Pack.
4	- 1/8	8.5	26.5	14	50
6	- 1/8	8.5	26.5	14	50
6	- 1/4	11	30	17	50
8	- 1/8	8.5	27.5	14	50
8	- 1/4	11	31	17	50
8	- 3/8	11.5	32.5	20	25
10	- 1/4	11	32.5	17	25
10	- 3/8	11.5	34.5	20	25
12	- 3/8	11.5	34.5	20	25
12	- 1/2	15	39	24	25
14	- 1/2	15	40	24	25
15	- 1/2	15	39.5	24	25
16	- 1/2	15	41	24	10
18	- 1/2	15	41	26	10

9550

RACCORDO A L ORIENTABILE - SINGLE BANJO BODY

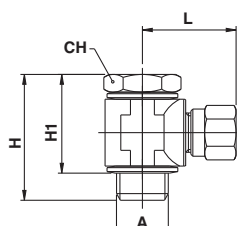

Tubo/Tube	A	L	H	H1	CH	Conf. Pack.
4	- 1/8	23	31	24	14	25
6	- 1/8	24	31	24	14	25
6	- 1/4	27.5	32	24.5	17	25
8	- 1/8	27.5	31	24	14	25
8	- 1/4	27.5	32	24.5	17	25
8	- 3/8	30	37.5	24.5	19	25
10	- 1/4	33	32	24.5	17	25
10	- 3/8	33.5	36	27.5	19	25
12	- 3/8	36	46	38	22	25

9680

DADO - NUT

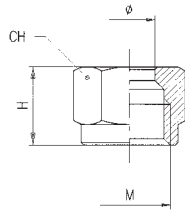

Tubo/Tube	H	CH	M	Conf. Pack.
4 LL	11	10	M8x1	50
6 LL	11.5	12	M10x1	50
8 LL	12	14	M12x1	50
10 L	15.5	19	M16x1.5	50
12 L	15.5	22	M18x1.5	50
14 S	18.5	27	M22x1.5	25
15 L	17	27	M22x1.5	25
16 S	18.5	30	M24x1.5	25
18 L	18	32	M26x1.5	25

9740

OGIVA - OLIVE

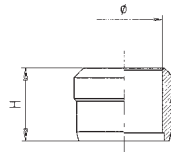

Tubo/Tube	H	Conf. Pack.
4 LL	6	50
6 LL	7	50
8 LL	7.5	50
10 L	9.5	50
12 L	9.5	50
14 S	9.5	25
15 L	9.5	25
16 S	9.5	25
18 L	10	25